

DTCM120-56-AL

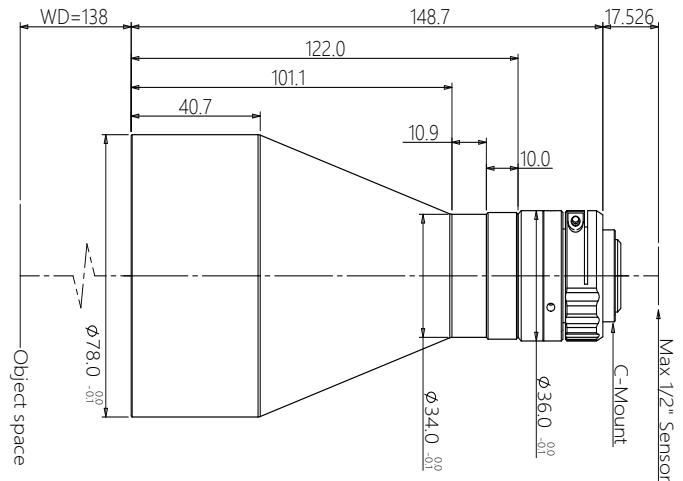

DTCM

-
- FOV 26mm 300mm
- 1/2.5" ~ 1.1" C
-

FOV(mm)	56
(x)	0.143
WD(mm)	138±3
CCD (mm)	8.0(1/2")
F/#	4.2
MTF30 (lp/mm)	>210
DoF(mm)	±21.5@F11
(% max)	<0.1
(° max)	<0.1
I/O(mm)	304±3

DTCL-56-xW-y

56mm



(mm x mm)

	C	1/2.5" 9P001/31 (5.7x4.28)	39.9x29.9
(mm)	148.7	1/2.3" 9J003 (6.44x4.62)	45.0x32.3
(kg)	0.6		

